

IMPULSIVE NOISE MITIGATION IN WAVELET
BASED ORTHOGONAL FREQUENCY DIVISION
MULTIPLEXING SYSTEMS

BY

MAAZ ELHAG ALI

INTERNATIONAL ISLAMIC UNIVERSITY MALAYSIA

2014

IMPULSIVE NOISE MITIGATION IN WAVELET
BASED ORTHOGONAL FREQUENCY DIVISION
MULTIPLEXING SYSTEMS

BY

MAAZ ELHAG ALI

A dissertation submitted in fulfilment of the requirement for
the degree of Master of Science
(Communication Engineering)

Kuliyah of Engineering
International Islamic University Malaysia

MARCH 2014

ABSTRACT

Multicarrier Modulation (MCM) is a widely used modulation scheme in broadband communications. It is superior to ordinary Single Carrier (SC) technique in terms of data rate, combating multipath and eliminating the effect of intersymbol interference (ISI) without using complex equalizers. The most common MCM scheme is Orthogonal Frequency Division Multiplexing (OFDM) and can be implemented using the Fast Fourier Transform (FFT) for modulation and demodulation. Wavelet-based OFDM as an alternative scheme to Fourier-OFDM has been recently adopted in some standards such as the IEEE 1901. This thesis is mainly about mitigating impulsive noise in wavelet-OFDM systems and this was achieved by using two mitigation techniques. The first method was by using blanking technique which is a common technique used in FFT-OFDM systems. This technique was used to mitigate the impulsive noise in all wavelet families under study which were Haar, Daubechies-4 and biorthogonal-4.4. The second technique, the replacing technique, was proposed and developed based on the mathematical analysis of the Haar discrete wavelet transform-OFDM. A redundancy in data was found and exploited to mitigate the impulsive noise. However, the performance of both techniques is highly dependent on the selection of threshold values. The results of the first technique showed that all wavelet types have approximately similar BER performance except the Haar wavelet family which had superior BER performance in most cases. Under the assumption of Bernoulli-Gaussian model for impulsive noise and BPSK-OFDM scheme, it was found that both techniques could achieve performance of BER of 1×10^{-4} with 5 dB gain in SNR when the probability of impulsive noise occurrence ($p = 0.001$). Achieving higher performance requires lowering the probability of occurrence. However, Assuming that there is an improper setting of the threshold value below or near the signal level, the replacing technique showed more immunity to errors. For a Haar DWT-OFDM, BPSK modulation and probability of impulsive noise occurrence of $p = 0.01$, the replacing technique was able to improve performance by 80% above the unmitigated case while this was 30% for the blanking technique when a threshold was set below 10% of its minimum value.

ملخص البحث

تستخدم تقنية التعديل متعدد الحوامل على نطاق واسع في مجال الاتصالات ذات النطاق العريض، و هي متفوقة على تقنية الحامل الأحادي الاعتيادية من حيث زيادة معدل البيانات، ومقاومة تأثير المسارات المتعددة، والتقليل من تأثير تداخل الرموز دون استخدام المعادلات المعقدة. المخطط الأكثر شيوعاً من هذه التقنية هو متعامد التردد بالتقسيم (OFDM) ويمكن تنفيذه باستخدام تحويل فورييه السريع، وتحويل فورييه السريع العكسي (FFT/IFFT) للتعديل والإستخلاص. نظام OFDM القائم على الموجات كمخطط بديل لنظام فورييه-OFDM اعتمد مؤخراً في بعض المعايير مثل IEEE1901. هذه الأطروحة حول تخفيف الضجيج النبضي في نظام الموجات-OFDM بشكل أساسي وتم تحقيق الهدف من خلال تقنيتين من تقنيات التخفيف. التقنية الأولى باستخدام تقنية المسح وهي تقنية شائعة وعملية مستخدمة في نظم فورييه-OFDM. وقد استخدم هذا الأسلوب للتخفيف من الضجيج النبضي في جميع أسر الموجات قيد الدراسة والتي كانت هار، دابوتشي - 4 وثنائي التعامد- 4.4. التقنية الثانية التي اقترحت وتم تنفيذها هي تقنية الاستبدال، والتي وضعت على أساس التحليل الرياضي لنظام OFDM المبني على الموجات المتقطعة لتحويل هار. تم العثور على التكرار في البيانات واستغلالها للتخفيف من الضوضاء النبضية. ومع ذلك، فإن الأداء في كل من التقنيتين يعتمد بشكل كبير على اختيار قيم العتبة (Threshold). وأظهرت نتيجة التقنية الأولى أن جميع أنواع الموجات متماثلة تقريباً في أداء معدل الخطأ في الأرقام الثنائية (BER) مع تفوق الموجات من نوع هار في أكثر الحالات. بافتراض نموذج برنولي-غاوس للضجيج النبضي، ومخطط ثنائي القطبية-OFDM، فقد وجد بأن كلا من التقنيتين استطاعت تحقيق أداء في معدل الخطأ في الأرقام الثنائية (BER) بمقدار $10^{-4} \times 1$ مع كسب في معدل قدرة الإشارة إلى قدرة الضجيج (SNR) بمقدار 5 ديسيبل عندما كانت احتمالية حدوث النبضات بمقدار $p=0.001$. ولتحقيق مستويات أداء أعلى يجب تخفيض احتمالية حدوث النبضات. على كل حال، فإنه وبافتراض وجود ضبط غير ملائم لقيمة العتبة بحيث تكون في مستوى الإشارة أو أدنى، فإن تقنية الاستبدال أظهرت مناعة أكثر للأخطاء. لنموذج الموجات هار-OFDM، ومخطط ثنائي القطبية، واحتمالية حدوث نبضات بمقدار $p=0.01$ ، فإن تقنية الاستبدال استطاعت تحسين الأداء بنسبة 80% فوق حالة عدم التخفيف، بينما كانت النسبة 30% لتقنية المسح وذلك عندما كانت العتبة أدنى بمقدار 10% من قيمتها الدنيا.

APPROVAL PAGE

I certify that I have supervised and read this study and that in my opinion; it conforms to acceptable standards of scholarly presentation and is fully adequate, in scope and quality, as a dissertation for the degree of Master of Science in Communication Engineering.

.....
Khaizuran Abdulllah
Supervisor

.....
Mohammad Umar Siddiqi
Co-Supervisor

I certify that I have read this study and that in my opinion; it conforms to acceptable standards of scholarly presentation and is fully adequate, in scope and quality, as a dissertation for the degree of Master of Science in Communication Engineering.

.....
Ahmad Fadzil Ismail
Examiner (Internal)

.....
Mohammad Yusof Alias
Examiner (External)

This dissertation was submitted to the Department of Electrical and Computer Engineering and is accepted as a fulfilment of the requirement for the degree of Master of Science in Communication Engineering.

.....
Othman O. Khalifa
Head, Department of Electrical
and Computer Engineering

This dissertation was submitted to the Kulliyah of Engineering and is accepted as a fulfilment of the requirement for the degree of Master of Science in Communication Engineering.

.....
Md. Noor B. Salleh
Dean, Kulliyah of Engineering

DECLARATION

I hereby declare that this dissertation is the result of my own investigations, except where otherwise stated. I also declare that it has not been previously or concurrently submitted as a whole for any other degrees at IIUM or other institutions.

Maaz Elhag Ali

Signature:.....

Date:.....

INTERNATIONAL ISLAMIC UNIVERSITY MALAYSIA

**DECLARATION OF COPYRIGHT AND AFFIRMATION
OF FAIR USE OF UNPUBLISHED RESEARCH**

Copyright © 2014 by Maaz Elhag Ali. All rights reserved.

**IMPULSIVE NOISE MITIGATION IN WAVELET BASED ORTHOGONAL
FREQUENCY DIVISION MULTIPLEXING SYSTEMS**

No part of this unpublished research may be reproduced, stored in a retrieval system, or transmitted, in any form or by any means, electronic, mechanical, photocopying, recording or otherwise without the permission of the copyright holder except as provided below.

1. Any material contained in or derived from this unpublished research may only be used by others in their writing with due acknowledgement.
2. IIUM or its library will have the right to make and transmit copies (print or electronic) for institutional and academic purpose.
3. The IIUM library will have the right to make, store in a retrieval system and supply copies of this unpublished research if requested by other universities and research libraries.

Affirmed by Maaz Elhag Ali

.....
Signature

.....
Date

ACKNOWLEDGEMENTS

Indeed, all praise is due to Allah, we praise Him, we seek His aid, and we ask for His forgiveness. We seek refuge in Allah from the evil of our actions and from the evil consequences of our actions. Whomever Allah guides, there is none to misguide and whoever Allah misguides there is none to guide. I bear witness that there is no god worthy of worship except Allah and I bear witness that Muhammad is the servant and messenger of Allah.

I would like to express my sincere appreciation to my supervisor, Dr.Khaizuran Abdullah, and co-supervisor, Prof.Dr.Mohammad Umar Siddiqi, for their guidance and support. Also, it is a good opportunity to acknowledge my close friend, Mohammad Khalid Hussain because he encouraged me to use L^AT_EX for writing this thesis.

2.5.2	Impulsive Noise Effect on Communication Systems	13
2.5.2.1	Digital Subscriber Loop (DSL).....	13
2.5.2.2	Digital Video Broadcasting (DVB).....	13
2.5.2.3	Power Line Communication	14
2.5.2.4	Wireless Communications	14
2.6	Impulsive Noise Mitigation Techniques	14
2.7	Summary	14
CHAPTER 3: SYSTEM MODELLING		15
3.1	Introduction.....	15
3.2	OFDM System	15
3.2.1	Wavelet-Based OFDM System.....	15
3.2.1.1	Haar	15
3.2.1.2	Daubechies-4 (Db2).....	15
3.2.1.3	Biorthogonal-4.4 (Bior4.4)	15
CHAPTER 4: PERFORMANCE OF THE OFDM SYSTEMS OVER AWGN & IMPULSIVE NOISE		17
4.1	Introduction.....	17
4.2	Performance of OFDM Systems Over AWGN.....	17
4.2.1	Analysing the Performance of OFDM Systems.....	17
4.2.2	Considerations for Signal Energy Calculations in OFDM Systems	17
4.2.2.1	Signal Energy Calculations in FFT-OFDM.....	17
4.2.2.2	Signal Energy Calculations in DWT-OFDM.....	17
4.2.3	Monte Carlo Simulation	17
4.2.3.1	Procedures of Monte Carlo Simulation.....	17
4.2.4	Simulation Results and Analysis.....	17
4.3	Performance of the OFDM Systems Over Both AWGN & IN Channel.....	18
4.3.1	Varying Both SNR and SINR ($\sigma_g^2 = f\sigma_w^2$)	18
4.3.2	Fixing SNR Varying SINR	18
4.3.3	Fixing SINR Varying SNR	18
4.3.4	Simulation Results and Analysis.....	18
4.3.4.1	Results Obtained By Maintaining: $\sigma_g^2 = f\sigma_w^2$	18
CHAPTER 5: MITIGATION OF IMPULSIVE NOISE IN DWT-BASED OFDM SYSTEMS		24
5.1	Introduction.....	24
5.2	Mitigation of Impulsive Noise Using Blanking Technique	24
5.2.1	Threshold Selection.....	24
5.2.1.1	Fixed Threshold.....	24
5.2.1.2	Optimized Threshold.....	24
5.2.1.3	Expected Threshold	25
5.2.2	Simulation Results and Analysis.....	25
5.2.2.1	Results of Fixed Threshold	25
5.2.2.2	Results of Optimized Threshold.....	25
5.2.2.3	Results of Expected Threshold	25
5.3	Impulsive Noise Mitigation Using the Replacing Technique for Haar DWT Based OFDM	25

5.3.1	Simulation Results and Analysis.....	25
5.4	Performance Comparison	25
5.5	Summary	25
CHAPTER 6: CONCLUSION AND FUTURE WORK		26
6.1	Conclusion	26
6.2	Key Findings, Contributions and Short Comings.....	26
6.3	Future Work	26
REFERENCES		27
PUBLICATIONS		29
APPENDIX A: Bit Error Rate (BER) for BPSK Modulation		30
APPENDIX B: Symbol Error Rate (SER) for QPSK Modulation		33
APPENDIX C: Symbol Error Rate (SER) for 16-QAM Modulation		36

LIST OF TABLES

<u>Table No.</u>		<u>Page No.</u>
2.1	Some differences between wavelet and Fourier transforms (Barford et al., 1992).	11
2.2	DVB standard specification (Woo et al., 2012).	13
2.3	FFT-OFDM PHY (Galli & Logvinov, 2008).	14
4.1	Results of OFDM systems in AWGN channel.	17
4.2	BPSK OFDM performance under AWGN & IN, $\sigma_g^2 = f\sigma_w^2$.	23

LIST OF FIGURES

<u>Figure No.</u>		<u>Page No.</u>
1.1	Research methodology.	5
2.1	Block diagram of MCM transmission (Yang, 2009).	8
2.2	Frequency response of the lowpass filter: $H_0(\omega) = \frac{1}{2} + \frac{1}{2}e^{-j\omega}$.	9
2.3	Frequency response of six subchannels (Sandberg, 1995).	12
3.1	Properties of 'bior4.4' wavelet.	16
4.1	Performance of BPSK OFDM systems in AWGN & IN ($\sigma_g^2 = 10\sigma_w^2$ with different values of occurrence probability, p).	20
4.2	Performance of BPSK OFDM systems in AWGN & IN ($\sigma_g^2 = 100\sigma_w^2$ with different values of occurrence probability p).	21
4.3	Performance of BPSK OFDM systems in AWGN & IN ($\sigma_g^2 = 1000\sigma_w^2$ with different values of occurrence probability, p).	22
A.1	BPSK transmitter and receiver.	30
B.1	QPSK constellation.	33
B.2	Conditional pdf for real part (QPSK) being in error (dark area).	34
B.3	Conditional pdf for imaginary part being in error (dark area).	34
C.1	16-QAM constellation.	36

LIST OF ABBREVIATIONS

ADSL	Asynchronous Digital Subscriber Loop.
AWGN	Additive White Gaussian Noise.
BER	Bit Error Rate.
BN	Blanking Nonlinearity.
BPSK	Bipolar Phase Shift Keying.
CP	Cyclic Prefix.
CS	Compressed Sensing.
D/A	Digital to Analog converter.
DFT	Discrete Fourier Transform.
DVB	Digital Video Broadcasting.
DWMT	Discrete Wavelet Multitone modulation.
DWT	Discrete Wavelet Transform.
FFT	Fourier Fast Transform.
HPF	High Pass Filter.
IDFT	Inverse Discrete Fourier Transform.
IDWT	Inverse Discrete Wavelet Transform.
IN	Impulsive Noise.
LPF	Low Pass Filter.
MCM	Multicarrier Modulation.
MSM	Multiscale Wavelet Modulation.
OFDM	Orthogonal Frequency Division Multiplexing.
PDF	Probability Density Function.
PLC	Power Line Communication.

PSD	Power Spectral Density.
PSTN	Public Switched Telephone Network.
QAM	Quadrature Amplitude Modulation.
QPSK	Quadrature Phase Shift Keying.
$S\alpha S$	Symmetric Alpha Stable.
S/P	Serial to Parallel converter.
SER	Symbol Error Rate.
SINR	Signal to Impulsive Noise Ratio.
SNR	Signal to Noise Ratio.
WPM	Wavelet Packet Modulation.

LIST OF SYMBOLS

$(\downarrow M)$	downsampling operation by M .
$(\uparrow L)$	upsampling operation by L .
B	Passband bandwidth.
B_c	Coherence bandwidth.
$F_0(\omega)$	Frequency response of synthesis lowpass filter.
$F_1(\omega)$	Frequency response of synthesis highpass filter.
$H_0(\omega)$	Frequency response of analysis lowpass filter.
$H_1(\omega)$	Frequency response of analysis highpass filter.
$P(z)$	Normalized product filter.
$P_0(z)$	Product filter.
X_k	Frequency domain input signal.
\Im	Imaginary part of a complex number.
\Re	Real part of a complex number.
\mathbf{B}	Analysis matrix.
\mathbf{L}	Synthesis matrix.
$\phi(t)$	Scaling function.
$f_0[n]$	Impulse response of synthesis lowpass filter.
$f_1[n]$	Impulse response of synthesis highpass filter.
$h_1[n]$	Impulse response of analysis highpass filter.
$h_o[n]$	Impulse response of analysis lowpass filter.
$w(t)$	Wavelet function.
x_i	Time domain input signal.

CHAPTER 1

INTRODUCTION

1.1 BACKGROUND

Multicarrier Modulation (MCM) is a widely used technique in broadband communication systems. This technique divides the transmitted data into several symbol streams of lower data rate and then transmits these substreams adjacently through subchannels after being modulated by subcarriers. The aim is to have bandwidth of each subchannel below the coherence bandwidth of the total channel, leading to flat fading subchannels (Goldsmith, 2005).

The most common scheme of MCM is Orthogonal Frequency Division Multiplexing (OFDM). Weinstein and Ebert (1971), made a major breakthrough in the implementation of multicarrier modulation. They proposed using Inverse Fourier Transform (IDFT) for modulation and Discrete Fourier Transform (DFT) for demodulation. It may be referred to as FFT-OFDM since the complexity of calculating N-DFT points can be reduced using Fast Fourier Transform (FFT).

Wavelets and filter banks are alternative methods to represent signals. They have been used in many applications like image processing and communication systems since 1980s. Unlike Fourier transform, wavelet transform uses short waves instead of long waves. When transforming to the frequency domain in Fourier transform, time information is lost. Wavelet transform was introduced to overcome this serious drawback of Fourier transform since it becomes possible to know when an event has occurred. Because of this and other properties of wavelet transform, they have been proposed in

some literature to replace FFT-OFDM systems (Strang & Nguyen, 1996).

Impulsive Noise (IN), characterized with short durations and very high amplitudes, is identified as an impairment that degrades performance of communication systems. It could be generated from man-made or atmospheric made sources. These may include switching noise, automobile engine noise, interfering electromagnetic pulses, and so on. Buses, circuits that connect the main parts of a computer, and clocks produce significant noise in laptop and desktop computers as well (Nassar, Gulati, DeYoung, Evans, & Tinsley, 2011).

1.2 PROBLEM STATEMENT AND ITS SIGNIFICANCE

Various types of noise can severely affect a wide range of communication systems. One of these noise sources is impulsive noise. For example, in a high speed Digital Subscriber Loop (DSL), impulsive noise sources may include lightning surges, vehicle ignitions, engine noise, electromagnetic discharge, transmission and switching gears (Zhidkov, 2006).

One of the studies on the effect of impulsive noise in ADSL found that without mitigating impulsive noise, impulses on ADSL lines could be 20 – 40 dB larger than either Additive White Gaussian Noise (AWGN) or near-end crosstalk; hence, a noise margin of 6 or 12 dB is not sufficient to protect ADSL from impulsive noise. Similarly, in Digital Video Broadcasting (DVB) systems, sources of impulsive noise seem to be the same as those of DSL (Al Mawali, 2011).

In Power Line Communication (PLC) systems, impulsive noise is considered the main reason for frames retransmission scenario (Zbydniowski, Zielinski, & Turcza, 29 2009-April 1). Unlike other communication environments, a channel in PLC is very

difficult to model (Al Mawali, 2011). It was found that the power spectral density (PSD) of impulsive noise is 50 dB higher than background noise (Al Mawali, 2011). In conventional OFDM systems (FFT-OFDM), it is required to add extra load, called the Cyclic Prefix (CP), to compensate for a high degree of spectral overlap.

As stated in one of the IEEE 802.16.3 proposals, overhead in wavelet-OFDM is less than of the FFT-OFDM because it does not require the addition of cyclic prefix. For wireless transmission, FFT-OFDM has a cyclic prefix of 20%; hence, wavelet-OFDM has an advantage of about 20% in bandwidth efficiency. Moreover, there is no need for pilot tones in wavelet-OFDM systems; however, some Fourier-OFDM systems use 4 out of 52 subbands for pilots which provide additional 8% advantage for wavelet-OFDM over FFT-OFDM implementations. Finally, unlike Fourier transform, wavelet transform can convert an input domain of real numbers to an output range of real numbers; hence, reducing the complexity of computation. Because wavelet-OFDM has higher spectral containment, i.e., overlapping, between sub-channels than FFT-OFDM, wavelet-OFDM is able to ameliorate the effects of narrowband interference and is more robust with respect to intersymbol interference and intercarrier interference (Zhao, Zhang, & Yuan, 2004). While most works have considered only FFT-OFDM, our work is directed to reduce the problem of impulsive noise in wavelet-OFDM.

1.3 SCOPE

This thesis focuses on wavelet-OFDM systems, particularly, the one which is described in (Abdullah, Kamarudin, Hussin, Jarrot, & Ismail, 2011) with three different wavelet families Haar, Daubechies-4 and biorthogonal-4.4. Majority of related works have considered mitigation of impulsive noise problem in FFT-OFDM systems. In this thesis,

the performance of FFT-OFDM compared with that of wavelet-OFDM in unmitigated impulsive noise environment.

Other aspects and challenges related to OFDM systems in general, like peak to average power ratio (PAPR) and frequency-timing offset are not considered in this work. The performance of a communication system is well- characterized by two curves, namely, spectral efficiency and bit error rate curves. However, this work focuses on performance in terms of bit error rate only.

1.4 RESEARCH OBJECTIVES

The following are the objectives of this work:

- i. To evaluate the performance of the system in terms of bit error rate (BER) and signal to noise ratio (SNR).
- ii. To compare the system performance using different wavelet families.
- iii. To develop a technique capable of mitigating impulsive noise in wavelet-OFDM system.

1.5 RESEARCH METHODOLOGY

The research starts with a literature review to cover basic concepts of the topic and related works in the area. After gaining enough background of the problem under investigation, a system model to be simulated and analysed. This will be followed by a study of the effect of impulsive noise in both wavelet-OFDM and Fourier transforms based OFDM systems. Benefiting from other works in the area, a technique will be developed to mitigate impulsive noise in wavelet-OFDM systems. The methodology of this research is shown in a flow chart diagram in Figure 1.1

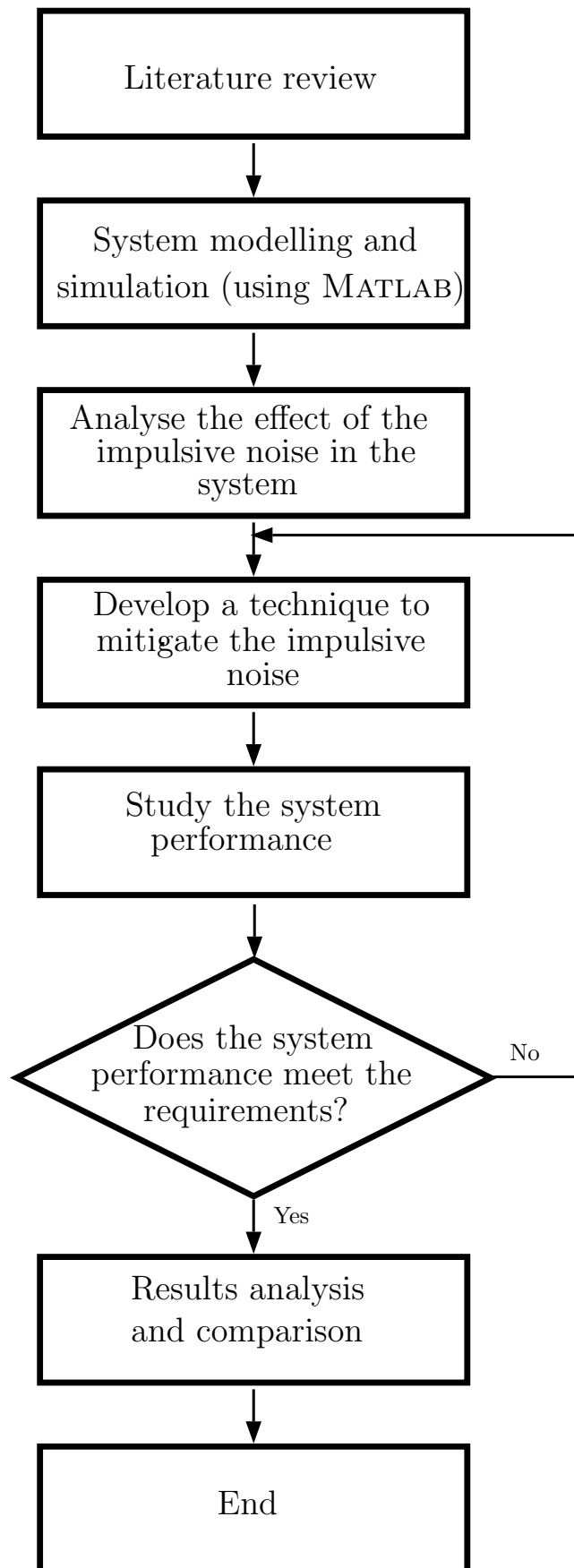

Figure 1.1: Research methodology.

1.6 THESIS ORGANIZATION

This thesis is divided into six chapters. Chapter 1 is the introduction and contains background, problem statement, research methodology and the objectives. Chapter 2, presents a literature review, principles and related works. Selecting a communication system for simulation and taking into consideration certain assumptions, tools, environments and MATLAB implementation of some important functions used in the study are covered in Chapter 3. Chapter 4 presents a performance study of OFDM systems for both Fourier transform and wavelet transform based OFDM systems. The main objective of the thesis, mitigating impulsive noise in wavelet-OFDM systems, its performance study and comparison are presented in Chapter 5. Chapter 6 ends with the conclusion of the work, short comings and future work.

CHAPTER 2

LITERATURE REVIEW

2.1 INTRODUCTION

A literature study is presented in this chapter covering basic concepts and principles of multicarrier modulation (MCM), practical implementation of MCM and the common techniques addressed to alleviate the effect of impulsive noise in MCM systems. The chapter is divided into seven sections. In Section 2.2, a literature review of multicarrier modulation technology is presented covering the basic principles and underlying theories of MCM systems. Section 2.3 explains the principle of Fourier based OFDM and the concept of cyclic prefix. Its counterpart, wavelet based system, is covered in Section 2.4 along with underlying theory of wavelet and filter banks. Impulsive noise definition, classes, statistical models and its effect on communication systems is presented in Section 2.5. A literature review of impulsive noise mitigation techniques is presented and evaluated in Section 2.6. Finally, Section 2.7 summarizes this chapter.

2.2 MULTICARRIER MODULATION

Lorem ipsum dolor sit amet, consectetur adipiscing elit. Ut purus elit, vestibulum ut, placerat ac, adipiscing vitae, felis. Curabitur dictum gravida mauris. Nam arcu libero, nonummy eget, consectetur id, vulputate a, magna. Donec vehicula augue eu neque. Pellentesque habitant morbi tristique senectus et netus et malesuada fames ac turpis egestas. Mauris ut leo. Cras viverra metus rhoncus sem. Nulla et lectus vestibulum urna fringilla ultrices. Phasellus eu tellus sit amet tortor gravida placerat. Integer sapien

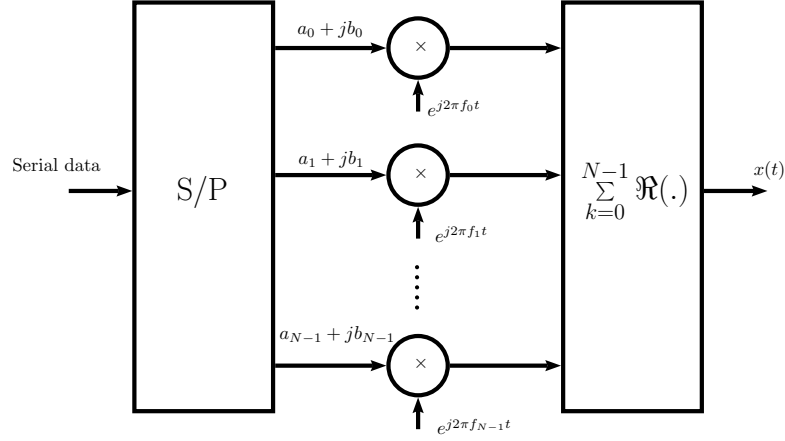

Figure 2.1: Block diagram of MCM transmission (Yang, 2009).

est, iaculis in, pretium quis, viverra ac, nunc. Praesent eget sem vel leo ultrices bibendum. Aenean faucibus. Morbi dolor nulla, malesuada eu, pulvinar at, mollis ac, nulla. Curabitur auctor semper nulla. Donec varius orci eget risus. Duis nibh mi, congue eu, accumsan eleifend, sagittis quis, diam. Duis eget orci sit amet orci dignissim rutrum. (Goldsmith, 2005),(Schulze & Lüders, 2005), (Bingham, 1990) and (Hara & Prasad, 2003) Figure 2.1 shows one possible configuration of MCM. First, a bit stream of data is divided into N substreams using a serial-to parallel converter (S/P). Then, each substream is mapped into symbols $s_i = a_i + jb_i$ (e.g. QAM or PSK mapping). By using an appropriate pulse shaping, each substream of symbols is modulated via a subcarrier f_i . Summing all the output from each branch, the transmitted signal, $s(t)$, can be written as (Yang, 2009):

$$s(t) = \sum_{i=0}^{N-1} \Re[e^{j2\pi f_i t}] \quad (2.1)$$

$$= \sum_{i=0}^{N-1} \Re[(a_i + jb_i)e^{j2\pi f_i t}]$$

$$= \sum_{i=0}^{N-1} [a_i \cos(2\pi f_i t) - b_i \sin(2\pi f_i t)] \quad (2.2)$$

2.3 FOURIER BASED OFDM MODULATION

2.3.1 Cyclic Prefix

2.4 WAVELET BASED OFDM MODULATION

2.4.1 Filter Banks

Figure 2.2 shows the response of a simple lowpass filter. This can be illustrated by the

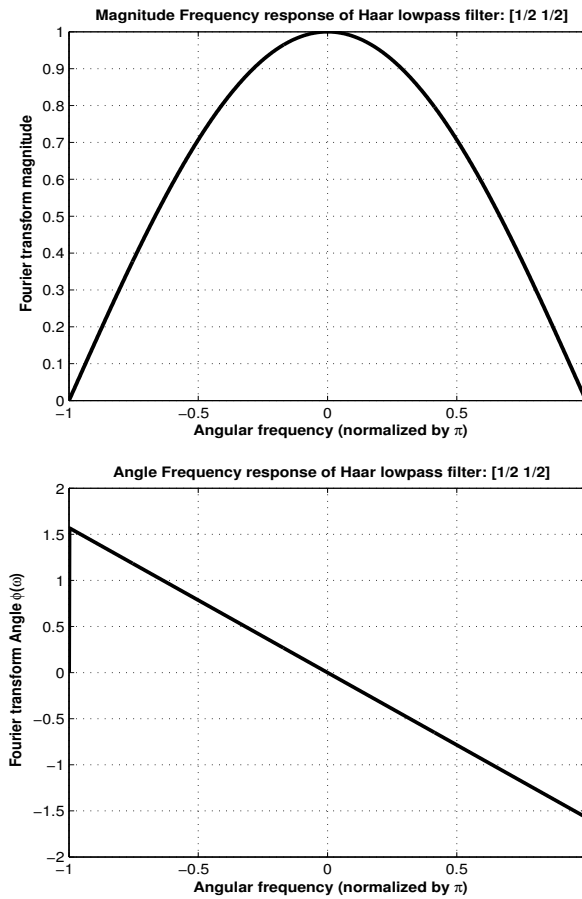

Figure 2.2: Frequency response of the lowpass filter: $H_0(\omega) = \frac{1}{2} + \frac{1}{2}e^{-j\omega}$.

following matrix operation:

$$(\downarrow 2)\mathbf{x}[n] = \begin{bmatrix} \vdots \\ \dots & 1 & 0 & 0 & 0 & 0 & \dots \\ \dots & 0 & 0 & 1 & 0 & 0 & \dots \\ \dots & 0 & 0 & 0 & 0 & 1 & \dots \\ \vdots \end{bmatrix} \begin{bmatrix} \vdots \\ x[0] \\ x[1] \\ x[2] \\ x[3] \\ x[4] \\ \vdots \end{bmatrix} = \begin{bmatrix} \vdots \\ x[0] \\ x[2] \\ x[4] \\ \vdots \end{bmatrix}$$

In general, if $\mathbf{x}[n]$ is an input to upsampling operation by L , the output $y[n]$ is:

$$\mathbf{y}[n] = \begin{cases} \mathbf{x}[n/L], & n = mL \\ 0, & n \neq mL \end{cases} \quad (2.3)$$

2.4.1.1 Haar Filter Bank

$$\begin{aligned} \mathbf{r}_0[n] &= \frac{1}{\sqrt{2}}(\mathbf{x}[n] + \mathbf{x}[n-1]) \\ \mathbf{y}_0[n] &= \mathbf{r}_0[2n] \\ \mathbf{y}_0[n] &= \frac{1}{\sqrt{2}}(\mathbf{x}[2n] + \mathbf{x}[2n-1]) \end{aligned} \quad (2.4)$$

Similarly,

$$\mathbf{y}_1[n] = \frac{1}{\sqrt{2}}(\mathbf{x}[2n] - \mathbf{x}[2n-1]) \quad (2.5)$$

2.4.1.2 Perfect Reconstruction and General Structure of the Two Channel Filter Banks

$$Q(z) = \frac{1}{2^{2p-1}} \sum_{k=0}^{p-1} \binom{p+k-1}{k} (-1)^k z^{-(p-1)+k} \left(\frac{1-z^{-1}}{2}\right)^{2k} \quad (2.6)$$

2.4.2 Scaling and Wavelet Functions

2.4.3 Wavelet Families

Table 2.1 shows the differences between wavelet and Fourier transforms.

Table 2.1
Some differences between wavelet and Fourier transforms (Barford et al., 1992).

	Fourier Transform	Wavelet Transform
“Root” function	$e^{j\omega t}$	$s^{-1/2}w(\frac{t-\tau}{s})$
Continuous Transform	$f(\omega) = \int_{-\infty}^{\infty} f(t)e^{-j\omega t} dt$	$w = \int_{-\infty}^{\infty} f(t)s^{-1/2}w(\frac{t-\tau}{s})$
Time transformed to	amplitude and phase for each frequency	amplitude for each scale and time
Input domain	\mathbb{R} or \mathbb{C}	\mathbb{R} or \mathbb{C}
Output range	\mathbb{C}	\mathbb{R} or \mathbb{C}
Localization in frequency	Yes	Yes
Localization in time	No (Limited with STFT)	Yes
Time for fast discrete transform	$O(n \log n)$	$O(n)$
Number of non-redundant outputs of discrete transform	n	n

2.4.4 Different Implementation of Wavelet Based OFDM

2.4.4.1 Multiscale Wavelet Modulation (MSM)

2.4.4.2 Wavelet Pulse Shaping of PAM

2.4.4.3 Wavelet Packet Modulation (WPM)

2.4.4.4 Overlapped Discrete Wavelet Multitone Modulation (DWMT)

2.4.5 Cyclic Prefix in Wavelet Based OFDM Systems

Figure 2.3 shows the frequency responses for six subchannels for a discrete multitone (DMT), which is a Fourier based OFDM, and a discrete wavelet multitone (DWMT).

Figure 2.3b is a particular type of wavelet with $g = 8$, where g is the overlap factor. It is clear that DWMT has better spectral concentration than DMT.

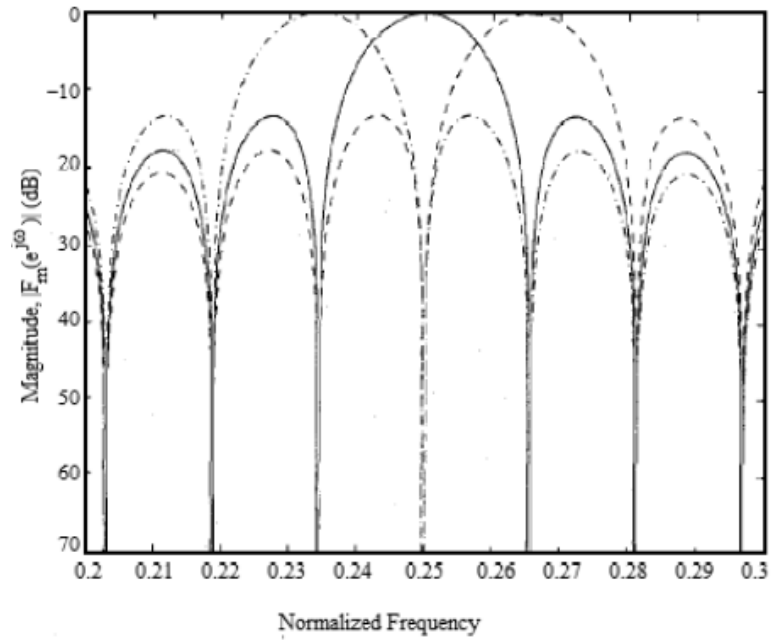

(a) DMT

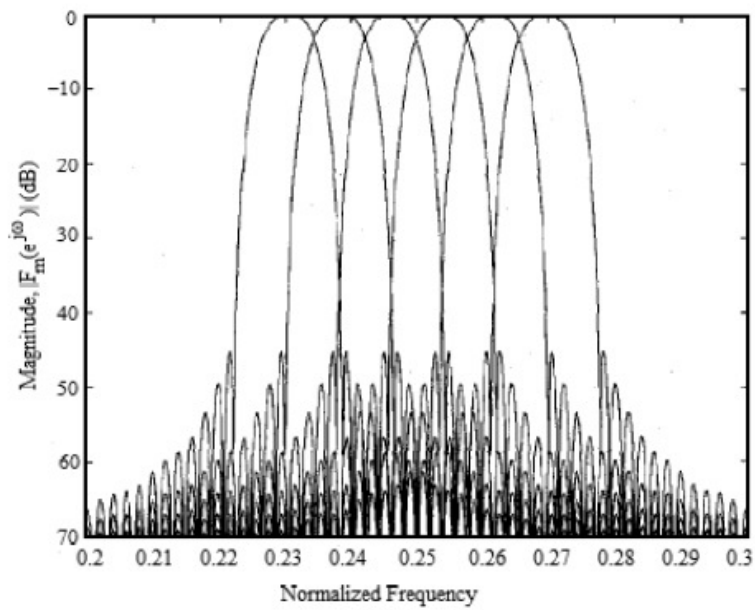

(b) DWMT

Figure 2.3: Frequency response of six subchannels (Sandberg, 1995).

2.5 IMPULSIVE NOISE (IN)

2.5.1 Statistical Models for Impulsive Noise

2.5.1.1 Binary-State Model

2.5.1.2 Bernoulli-Gaussian Model

2.5.1.3 Poisson-Gaussian Model

2.5.1.4 Middleton Class A Model

2.5.1.5 Symmetric Alpha Stable ($S\alpha S$)

2.5.2 Impulsive Noise Effect on Communication Systems

2.5.2.1 Digital Subscriber Loop (DSL)

2.5.2.2 Digital Video Broadcasting (DVB)

Table 2.2 shows DVB standard specifications (Woo et al., 2012).

Table 2.2
DVB standard specification (Woo et al., 2012).

	DVB-T	DVB-H	DVB-T2	DVB-S2
Modulation	QPSK, 16QAM, 64QAM	QPSK, 16QAM, 64QAM	QPSK, 16QAM, 64QAM, 256QAM	QPSK, 8PSK, 16APSK, 32APSK
PHY FEC	CC + RS 1/2, 2/3, 3/4, 7/8	CC + RS 1/2, 2/3, 3/4, 7/8	BCH + LDPC 1/2, 3/5, 2/3, 3/4, 4/5, 5/6	BCH + LDPC 1/4, 1/3, 2/5, 1/2, 3/5, 2/3, 3/4, 4/5, 5/6, 8/9, 9/10
FFT Size	2k, 8k	2k, 4k, 8k	1k, 2k, 4k, 8k, 16k, 32k	-
Guard Interval	1/4, 1/8, 1/16, 1/32	1/4, 1/8, 1/16, 1/32	1/4, 19/256, 1/8, 19/128, 1/16, 1/32, 1/128	-
PHY/Link Layer I/F	MPEG-2 TS	MPEG-2TS	BaseBand Frame	BaseBand Frame
Link Layer	-	MPE	GSE	GSE

2.5.2.3 Power Line Communication

Tables 2.3 shows the parameters for FFT-OFDM PHY.

Table 2.3
FFT-OFDM PHY (Galli & Logvinov, 2008).

Communication method	Fast Fourier transform (FFT) OFDM
FFT points	3072, 6144
Sampling frequency (MHz), respectively	75, 150
Symbol length (μs)	40.96
Guard interval (μs)	Variable according to line conditions: 5.56, 7.56, 47.12
Primary modulation (per subcarrier)	BPSK, QPSK, 8-, 16-, 64-, 256-, 1024-, and 4096-QAM
Frequency band (MHz)	2 – 30 (optional bands: 2 – 48 and 2 – 60)
Error correction	Turbo convolutional coding
Maximum transmission speed (Mb/s)	545 (8/9 CTC)
Diversity modes	Normal ROBO, mini ROBO, high-speed ROBO, and frame control

2.5.2.4 Wireless Communications

2.6 IMPULSIVE NOISE MITIGATION TECHNIQUES

2.7 SUMMARY

CHAPTER 3

SYSTEM MODELLING

3.1 INTRODUCTION

3.2 OFDM SYSTEM

3.2.1 Wavelet-Based OFDM System

$$s = \text{conv}(\text{dyadup}(x_a), f_0) + \text{conv}(\text{dyadup}(x_d), f_1);$$

while the analysis side (receiver) is implemented as:

$$x_a = \text{dyaddown}(\text{conv}(s, h_0))$$

$$x_d = \text{dyaddown}(\text{conv}(s, h_1))$$

where the command 'conv' is a convolution operation, 'dyadup' and 'dyaddown' are, respectively, upsampling and downsampling (by 2) operations, f_0 and f_1 are the lowpass and the highpass filter coefficients, respectively, of the synthesis side; h_0 and h_1 are the lowpass and highpass filter coefficients of the analysis side. All these terms are discussed in Section 2.4.

3.2.1.1 Haar

3.2.1.2 Daubechies-4 (Db2)

3.2.1.3 Biorthogonal-4.4 (Bior4.4)

Figure 3.1 shows properties of this wavelet.

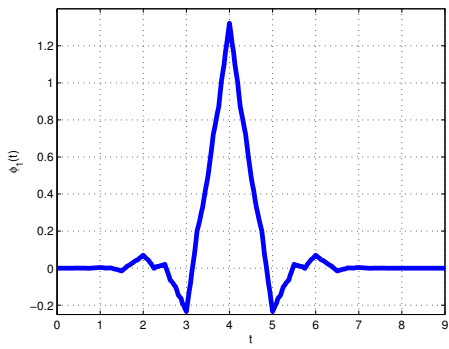

(a) Analysis scaling function $\phi_1(t)$

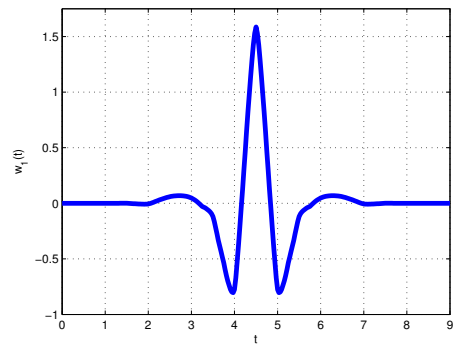

(b) Analysis wavelet function $w_1(t)$

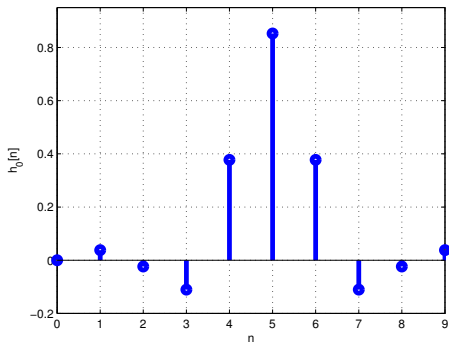

(c) Analysis low-pass filter h_0

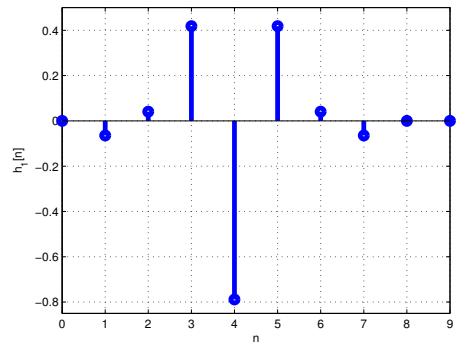

(d) Analysis high-pass filter h_1

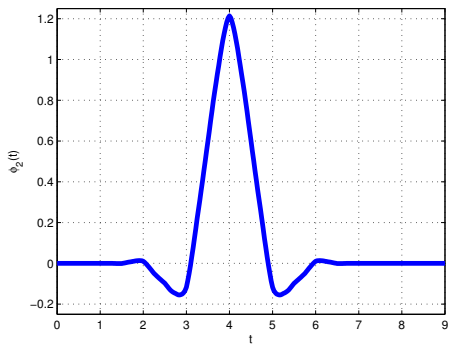

(e) Synthesis scaling function $\phi_2(t)$

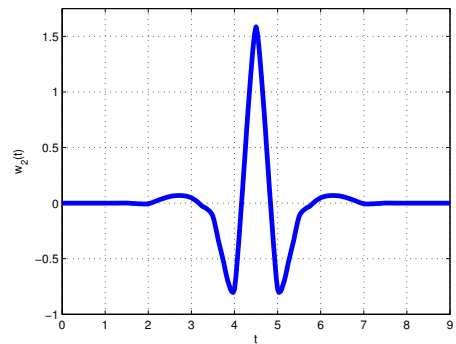

(f) Synthesis wavelet function $w_2(t)$

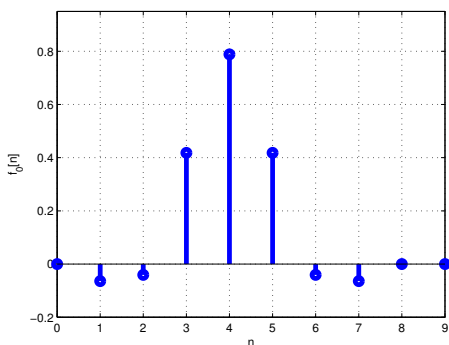

(g) Synthesis low-pass filter f_0

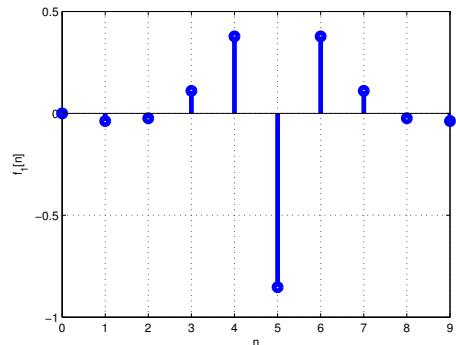

(h) Synthesis high-pass filter f_1

Figure 3.1: Properties of 'bior4.4' wavelet.

CHAPTER 4

PERFORMANCE OF THE OFDM SYSTEMS OVER AWGN & IMPULSIVE NOISE

4.1 INTRODUCTION

4.2 PERFORMANCE OF OFDM SYSTEMS OVER AWGN

4.2.1 Analysing the Performance of OFDM Systems

4.2.2 Considerations for Signal Energy Calculations in OFDM Systems

4.2.2.1 *Signal Energy Calculations in FFT-OFDM*

4.2.2.2 *Signal Energy Calculations in DWT-OFDM*

4.2.3 Monte Carlo Simulation

4.2.3.1 *Procedures of Monte Carlo Simulation*

4.2.4 Simulation Results and Analysis

Table 4.1
Results of OFDM systems in AWGN channel.

Scheme	Required SNR to achieve	
	SER= 10^{-5}	BER= 10^{-5}
BPSK	9.5 dB	9.5 dB
QPSK	13 dB	12.5 dB
16-QAM	20 dB	19.3 dB

Procedure 4.1 Monte Carlo Simulation (FFT-OFDM)

procedure CALCULATEBITERRORRATE (BER)

$$N_{FFT} = 64, N_{st} = 52, N_{cp} = 16$$

$$nSymbols = 5000;$$

$$nBits = nBit\ per\ Symbol \times nSymbol,$$

$$SNR = [0 : 2 : 20], ,,$$

$$SNR_{FFT,eff} = SNR + 10\log_{10}\left(\frac{N_{st}}{N_{FFT}}\right) + 10\log_{10}\left(\frac{N_{FFT}}{N_{cp} + N_{FFT}}\right)$$

for i=1:length(SNR) **do**

$$ipBits \mapsto X_i$$

$$x_n = ifft(X_i)$$

$$s_k = x_n + x_n(49 : 64)$$

$$w_k = \frac{1}{\sqrt{2}}(randn(1, length(s_k)) + j * randn(1, length(s_k)))$$

$$r_k = s_k + 10^{-\frac{SNR_{eff}}{20}} \cdot w_k$$

$$y_n = r_k(17 : 80)$$

$$Y_i = fft(y_n)$$

$$nSymbolsError \leftarrow Y_i \neq X_i$$

$$Y_i \mapsto opBits$$

$$nBitsError \leftarrow ipBits \neq opBits$$

end for

$$SER = \frac{nSymbolsError}{nSymbols \times N_{st}}$$

$$BER = \frac{nBitsError}{nBits}$$

end procedure

4.3 PERFORMANCE OF THE OFDM SYSTEMS OVER BOTH AWGN & IN CHANNEL

4.3.1 Varying Both SNR and SINR ($\sigma_g^2 = f\sigma_w^2$)

4.3.2 Fixing SNR Varying SINR

4.3.3 Fixing SINR Varying SNR

4.3.4 Simulation Results and Analysis

4.3.4.1 Results Obtained By Maintaining: $\sigma_g^2 = f\sigma_w^2$

Figures 4.1, 4.2 and 4.3 show the results obtained accordingly.

From Figure 4.1a, for example, ‘heavily-disturbed environment’, $p = 0.1$, and high impulsive noise power ($\sigma_g^2 = 10\sigma_w^2$), it can be seen It is reduced in cases of increasing the impulsive power; for example, when ($\sigma_g^2 = 100\sigma_w^2$) (Figure 4.2a),FFT-OFDM

curve moves closer to the AWGN when decreasing the probability of occurrence, for example, it has the same performance for AWGN to achieve 10^{-4} (Figure 4.1c). (Figures (4.1c) and 4.2c). DWT-OFDM is superior in performance in regions of low BER. The best performance of DWT-OFDM was achieved in the simulation compared to FFT is the situation when very high IN power in an environment weakly-disturbed by IN; for example, 4.3c where at SNR= 10 dB DWT could achieve BER of 1×10^{-3} , while it is 1×10^{-2} for FFT-OFDM. Table 4.2 summarizes these results.

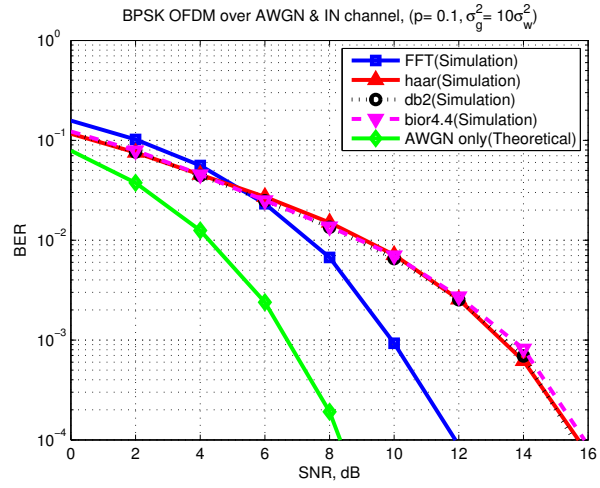

(a) $p = 0.1$

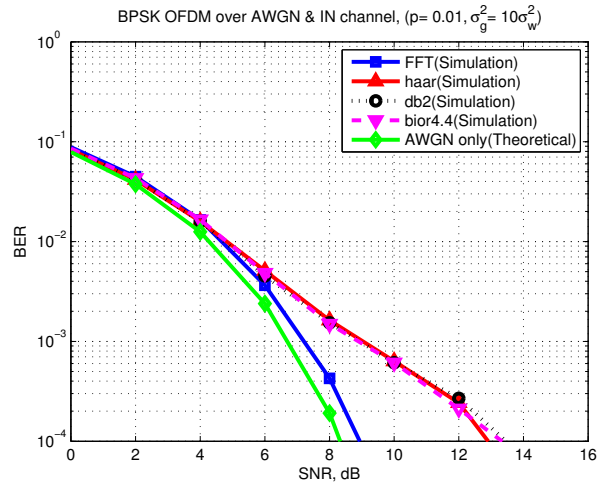

(b) $p = 0.01$

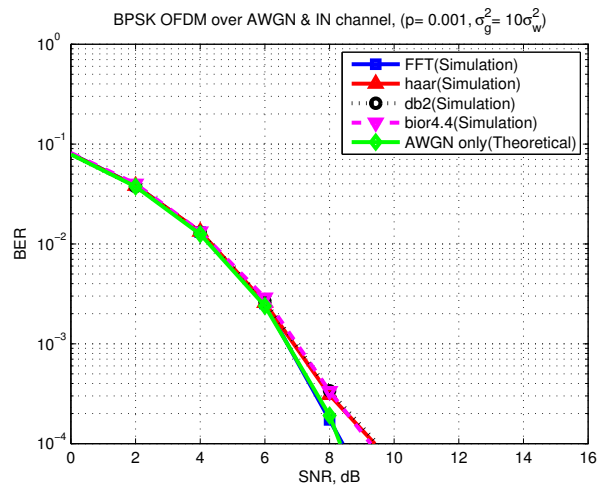

(c) $p = 0.001$

Figure 4.1: Performance of BPSK OFDM systems in AWGN & IN ($\sigma_g^2 = 10\sigma_w^2$ with different values of occurrence probability, p).

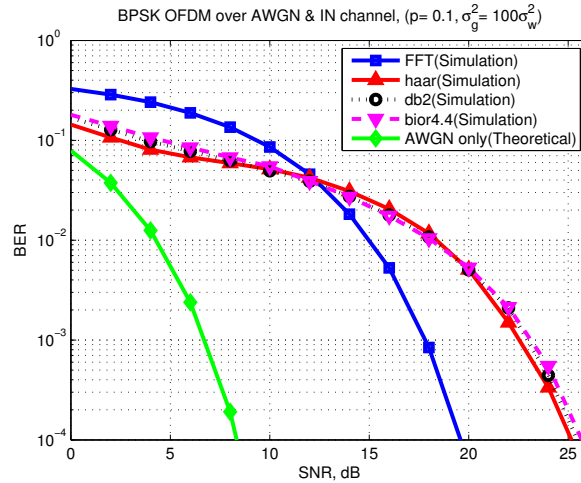

(a) $p = 0.1$

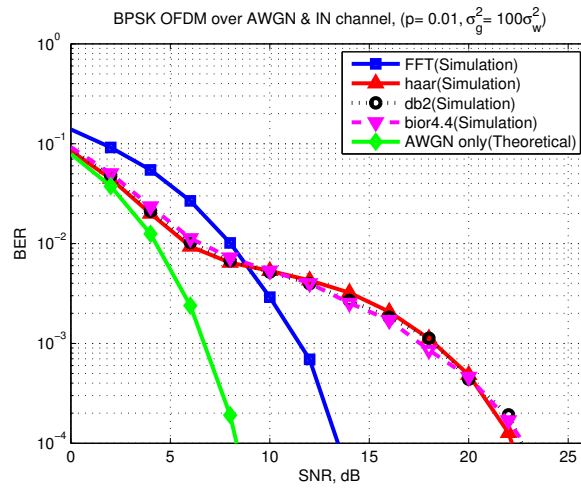

(b) $p = 0.01$

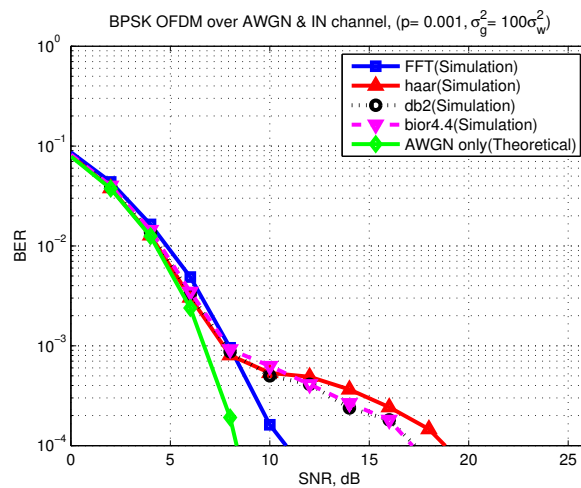

(c) $p = 0.001$

Figure 4.2: Performance of BPSK OFDM systems in AWGN & IN ($\sigma_g^2 = 100\sigma_w^2$ with different values of occurrence probability p).

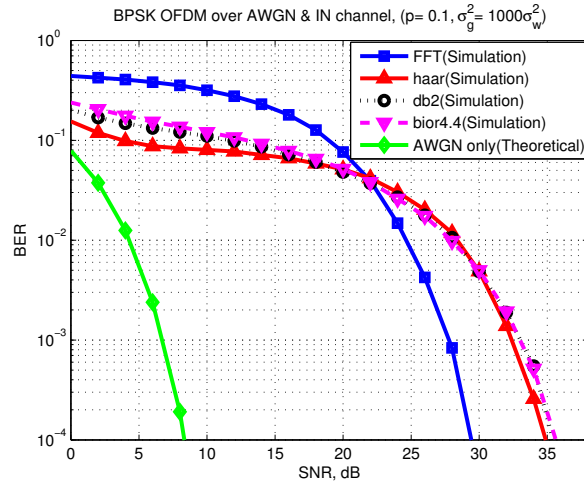

(a) $p = 0.1$

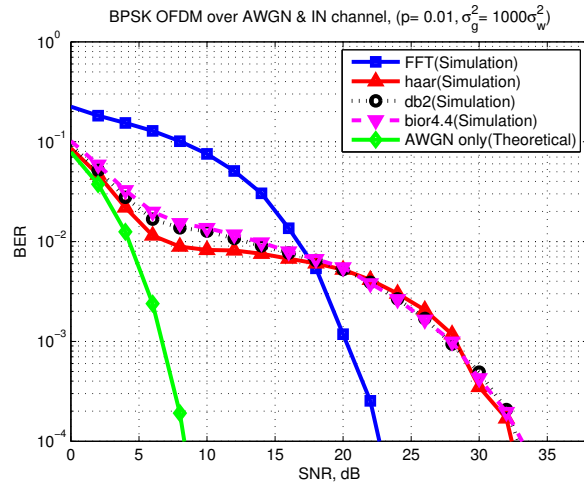

(b) $p = 0.01$

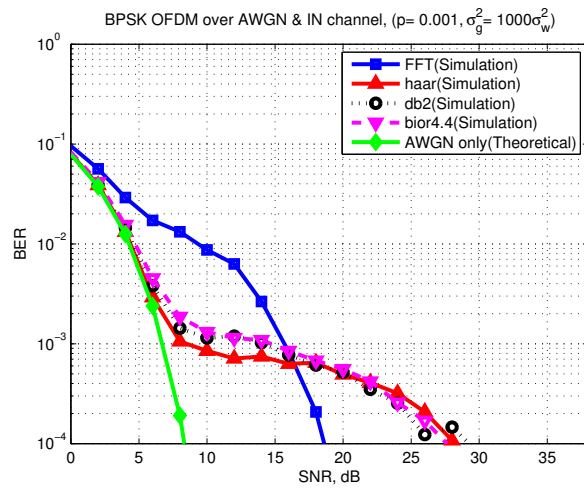

(c) $p = 0.001$

Figure 4.3: Performance of BPSK OFDM systems in AWGN & IN ($\sigma_g^2 = 1000\sigma_w^2$ with different values of occurrence probability, p).

Table 4.2
BPSK OFDM performance under AWGN & IN, $\sigma_g^2 = f\sigma_w^2$.

p	SNR at BER = 10^{-4}			Same (DWT & FFT) performance region or point SNR	Best DWT performance point (compared to FFT) BER	SNR	BER _{DWT}
	AWGN (BER of DWT)	DWT (BER of FFT)	FFT (BER of DWT)				
$\sigma_g^2 = 10\sigma_w^2$	0.1	8.5 dB 1×10^{-2}	15.8 dB -	12 3×10^{-3}	= 6 dB	3×10^{-2}	= 0 dB 1×10^{-1}
	0.01	8.5 dB 1.5×10^{-3}	13 dB -	8.8 dB 1×10^{-3}	< 2 dB	3×10^{-2}	-
	0.001	8.5 dB 2×10^{-4}	9.5 dB -	8.5 dB 2×10^{-4}	< 6 dB	1×10^{-3}	-
$\sigma_g^2 = 100\sigma_w^2$	0.1	8.5 dB 6×10^{-2}	25 dB -	19 7×10^{-3}	= 12 dB	= 4×10^{-2}	= 4 dB 1×10^{-1}
	0.01	8.5 dB 7×10^{-3}	22.5 dB -	13.5 dB 3×10^{-3}	= 9 dB	= 6×10^{-3}	-
	0.001	8.5 dB 8×10^{-4}	18 dB -	11 dB 5×10^{-4}	< 6 dB	1×10^{-3}	-
$\sigma_g^2 = 1000\sigma_w^2$	0.1	8.5 dB 7×10^{-2}	35 dB -	29.5 dB 7×10^{-3}	= 22 dB	= 4×10^{-2}	= 4 dB 1×10^{-1}
	0.01	8.5 dB 8×10^{-3}	33 dB -	22.5 dB 4×10^{-3}	= 18 dB	= 6×10^{-3}	-
	0.001	8.5 dB 8×10^{-4}	28 dB -	18.5 dB 6×10^{-4}	= 16 dB	6×10^{-4}	-

CHAPTER 5

MITIGATION OF IMPULSIVE NOISE IN DWT-BASED OFDM SYSTEMS

5.1 INTRODUCTION

5.2 MITIGATION OF IMPULSIVE NOISE USING BLANKING TECHNIQUE

5.2.1 Threshold Selection

5.2.1.1 Fixed Threshold

5.2.1.2 Optimized Threshold

Algorithm 5.1 Finding the optimum threshold

```
procedure FINDOPTIMUMTHRESHOLD ( $T_{th,opt_i}$ )  
  SNR = [0 : 2 : 20],  $\mathbf{T}_{th}$  = [0 : 0.1 : 7]  
  for i=1:length(SNR) do  
    for j=1:length( $\mathbf{T}_{th}$ ) do  
      procedure CALCULATEBITERRORRATE (BER( $T_{th,j}$ ))  
      end procedure  
    end for  
     $T_{opt,i} = T_{th}(j) \leftarrow \text{minimum}(\text{BER}(T_{th,j}))$   
  end for  
end procedure
```

5.2.1.3 *Expected Threshold*

5.2.2 Simulation Results and Analysis

5.2.2.1 *Results of Fixed Threshold*

5.2.2.2 *Results of Optimized Threshold*

5.2.2.3 *Results of Expected Threshold*

5.3 IMPULSIVE NOISE MITIGATION USING THE REPLACING TECHNIQUE FOR HAAR DWT BASED OFDM

5.3.1 Simulation Results and Analysis

5.4 PERFORMANCE COMPARISON

5.5 SUMMARY

CHAPTER 6

CONCLUSION AND FUTURE WORK

6.1 CONCLUSION

6.2 KEY FINDINGS, CONTRIBUTIONS AND SHORT COMINGS

6.3 FUTURE WORK

REFERENCES

- Abdullah, K., Kamarudin, S. I., Hussin, N. F., Jarrot, S. P., & Ismail, A. F. (2011). Impulsive noise effects on DWT-OFDM versus FFT-OFDM. In *Communications (APCC), 2011 17th Asia-Pacific Conference on* (pp. 488–491).
- Al Mawali, K. (2011). *Techniques for Broadband Power Line Communications: Impulsive Noise Mitigation and Adaptive Modulation* (Unpublished doctoral dissertation). RMIT University.
- Barford, L. A., Fazio, R. S., & Smith, D. R. (1992). *An introduction to wavelets*. Hewlett-Packard Laboratories, Technical Publications Department.
- Bingham, J. (1990). Multicarrier modulation for data transmission: An idea whose time has come. *Communications Magazine, IEEE*, 28(5), 5–14.
- Galli, S., & Logvinov, O. (2008). Recent developments in the standardization of power line communications within the IEEE. *Communications Magazine, IEEE*, 46(7), 64–71.
- Goldsmith, A. (2005). *Wireless communications*. Cambridge university press.
- Hara, S., & Prasad, R. (2003). *Multicarrier techniques for 4G mobile communications*. Artech House Publishers.
- Nassar, M., Gulati, K., DeYoung, M. R., Evans, B. L., & Tinsley, K. R. (2011). Mitigating near-field interference in laptop embedded wireless transceivers. *Journal of Signal Processing Systems*, 63(1), 1–12.
- Sandberg, S. (1995). Adapted demodulation for spread-spectrum receivers which employ transform-domain interference excision. *Communications, IEEE Transactions on*, 43(9), 2502–2510.
- Schulze, H., & Lüders, C. (2005). *Theory and Applications of OFDM and CDMA: Wideband Wireless Communications*. Wiley.
- Strang, G., & Nguyen, T. (1996). *Wavelets and filter banks*. Cambridge University Press.
- Weinstein, S., & Ebert, P. (1971). Data transmission by frequency-division multiplexing using the discrete Fourier transform. *Communication Technology, IEEE Transactions on*, 19(5), 628–634.

- Woo, Y., Lee, K., Kwon, K. W., Seo, J. W., & Kang, M. G. (2012). Design and realization of DVB-T/DVB-T2 dual mode receiver system. In *Consumer Electronics (ICCE), 2012 IEEE International Conference on* (p. 386-387). doi: 10.1109/ICCE.2012.6161914
- Yang, L. (2009). *Multicarrier communications*. Wiley.
- Zbydniewski, L., Zielinski, T., & Turcza, P. (29 2009-April 1). Influence of time-frequency tiling on BER performance in Discrete Wavelet Multitone power line transmission. In *Power Line Communications and Its Applications, 2009. ISPLC 2009. IEEE International Symposium on* (p. 182-187). doi: 10.1109/ISPLC.2009.4913426
- Zhao, F., Zhang, H., & Yuan, D. (2004). Performance of COFDM with different orthogonal bases on AWGN and frequency selective channel. In *Emerging Technologies: Frontiers of Mobile and Wireless Communication, 2004. Proceedings of the IEEE 6th Circuits and Systems Symposium on* (Vol. 2, pp. 473-475).
- Zhidkov, S. V. (2006). Performance analysis and optimization of OFDM receiver with blanking nonlinearity in impulsive noise environment. *Vehicular Technology, IEEE Transactions on*, 55(1), 234-242.

PUBLICATIONS

Elhag Ali, M., Abdullah, K., Siddiqi, M., & Ismail, A. F. (2013, November). Impulsive Noise Mitigation in Haar DWT Based OFDM systems. In *2013 IEEE 11th Malaysia International Conference on Communications (MICC 2013) (MICC'13)*. Kuala Lumpur, Malaysia.

APPENDIX A

BIT ERROR RATE (BER) FOR BPSK MODULATION

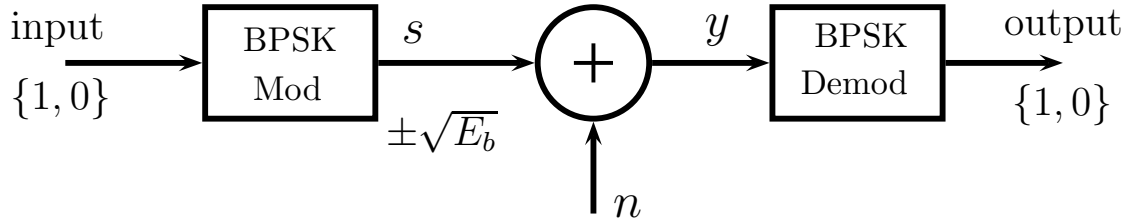

Figure A.1: BPSK transmitter and receiver.

In Binary phase shift keying scheme, the input bits 1 and 0 could be represented by two analogue levels; $\sqrt{E_b}$ for symbol 1 and $-\sqrt{E_b}$ for symbol 0. Figure A.1 shows a block diagram for a typical BPSK transmitter and receiver.

When the signal is to be sent over the channel it will experience noise n , which is additive white Gaussian noise.

The received signal:

$$y = \begin{cases} s_1 + n, & \text{if bit 1 is transmitted} \\ s_0 + n, & \text{if bit 0 is transmitted} \end{cases}$$

The conditional probability distribution function (PDF) (Figure A.2) of y for the two signals are:

$$f(y/s_0) = \frac{1}{\sqrt{\pi N_0}} e^{-\frac{(y+\sqrt{E_b})^2}{N_0}} \quad (\text{A.1})$$

$$f(y/s_1) = \frac{1}{\sqrt{\pi N_0}} e^{-\frac{(y-\sqrt{E_b})^2}{N_0}} \quad (\text{A.2})$$

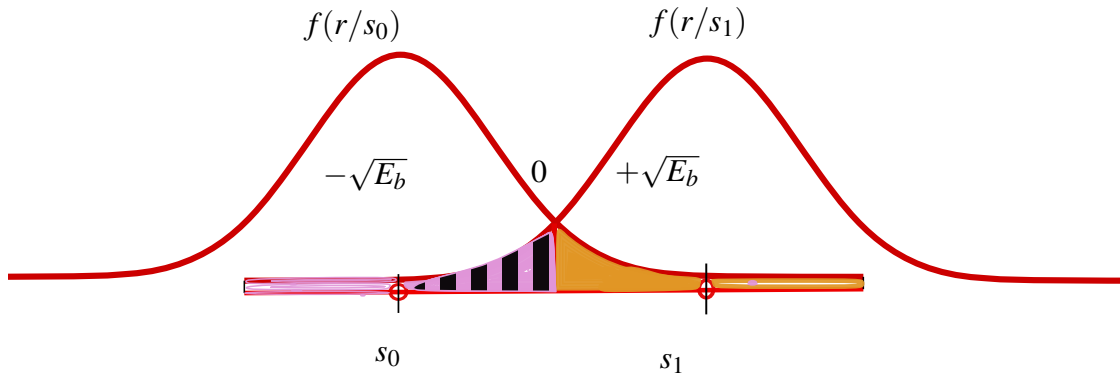

Figure A.2: The conditional probability distribution function with BPSK.

Assuming an equiprobable transmitted bits, i.e., $P(s_1) = P(s_0) = \frac{1}{2}$, the threshold 0 is the optimal decision boundary. If the received signal is greater than the threshold, the receiver decides s_1 was transmitted, otherwise, it decides that s_0 is transmitted. mathematically;

$$y > 0 \Rightarrow s_1$$

$$y \leq 0 \Rightarrow s_0$$

The probability of error given s_1 was transmitted:

$$f(e|s_1) = \frac{1}{\sqrt{\pi N_0}} \int_{-\infty}^0 e^{-\frac{(y-\sqrt{E_b})^2}{N_0}} dy \quad (\text{A.3})$$

$$= \frac{1}{\sqrt{\pi}} \int_{\frac{\sqrt{E_b}}{\sqrt{N_0}}}^{\infty} e^{-z^2} dz \quad (\text{A.4})$$

$$= \frac{1}{2} \text{erfc}\left(\sqrt{\frac{E_b}{N_0}}\right) \quad (\text{A.5})$$

where

$$\text{erfc}(x) = \frac{2}{\sqrt{\pi}} \int_x^{\infty} e^{-x^2} dx \quad (\text{A.6})$$

is the complementary error function.

Similarly, the probability of error given s_0 is transmitted

$$f(e|s_0) = \frac{1}{\sqrt{\pi N_0}} \int_0^{\infty} e^{-\frac{(y+\sqrt{E_b})^2}{N_0}} dy \quad (\text{A.7})$$

$$= \frac{1}{\sqrt{\pi}} \int_{\frac{\sqrt{E_b}}{\sqrt{N_0}}}^{\infty} e^{-z^2} dz \quad (\text{A.8})$$

$$= \frac{1}{2} \text{erfc}\left(\sqrt{\frac{E_b}{N_0}}\right) \quad (\text{A.9})$$

The total probability of bit error:

$$P_b = P(s_1)f(e|s_1) + P(s_0)f(e|s_0) \quad (\text{A.10})$$

$$P_b = \frac{1}{2} \text{erfc}\left(\sqrt{\frac{E_b}{N_0}}\right) \quad (\text{A.11})$$

APPENDIX B

SYMBOL ERROR RATE (SER) FOR QPSK MODULATION

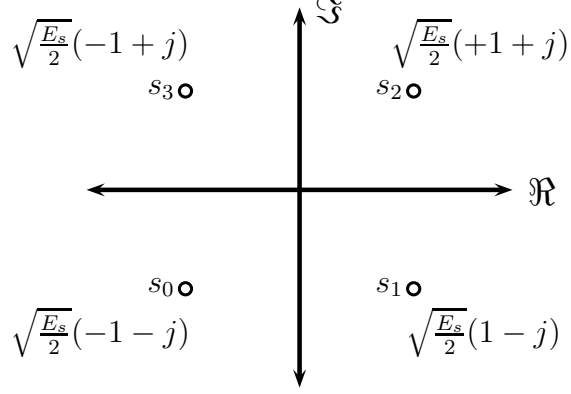

Figure B.1: QPSK constellation.

Assuming the alphabets used for QPSK are $\alpha_{QPSK} = \{\pm 1 \pm 1j\}$, the constellation diagram for QPSK is shown in Figure B.1. The factor $\sqrt{\frac{E_s}{2}}$ is a normalization factor, i.e., to normalize the average energy of the transmitted symbols to 1, assuming that all symbols are equiprobable.

The conditional probability distribution function (PDF) of y given s_2 was transmitted (Figure B.2):

$$f(y/s_2) = \frac{1}{\sqrt{\pi N_0}} e^{-\frac{(y - \sqrt{\frac{E_s}{2}})^2}{N_0}} \quad (\text{B.1})$$

From figure B.2, symbol s_2 is detected correctly if y falls in the hashed area, i.e.,

$$f(c|s_2) = f(\Re\{y\} > 0|s_2)f(\Im\{y\}|s_2) \quad (\text{B.2})$$

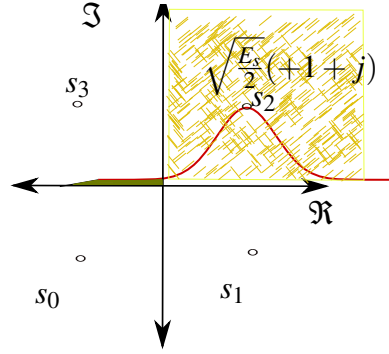

Figure B.2: Conditional pdf for real part (QPSK) being in error (dark area).

Probability of real part of $y > 0$, given s_2 was sent (i.e, dark area) is:

$$f(\Re\{y\} > 0 | s_2) = 1 - \frac{1}{\sqrt{\pi N_0}} \int_{-\infty}^0 e^{-\frac{(\Re\{y\} - \sqrt{\frac{E_s}{2}})^2}{N_0}} dy \quad (\text{B.3})$$

$$= 1 - \frac{1}{2} \text{erfc}\left(\sqrt{\frac{E_s}{2N_0}}\right) \quad (\text{B.4})$$

Similarly, for the imaginary part of y (Figure B.3):

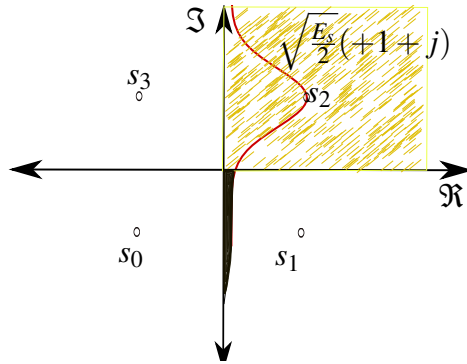

Figure B.3: Conditional pdf for imaginary part being in error (dark area).

$$f(\Im\{y\} > 0 | s_2) = 1 - \frac{1}{\sqrt{\pi N_0}} \int_{-\infty}^0 e^{-\frac{(\Im\{y\} - \sqrt{\frac{E_s}{2}})^2}{N_0}} dy \quad (\text{B.5})$$

$$= 1 - \frac{1}{2} \text{erfc}\left(\sqrt{\frac{E_s}{2N_0}}\right) \quad (\text{B.6})$$

The probability of s_2 being decoded correctly is,

$$f(c|s_2) = \left[1 - \frac{1}{2} \operatorname{erfc} \left(\sqrt{\frac{E_s}{2N_0}} \right) \right]^2 \quad (\text{B.7})$$

$$= \left[1 - \frac{2}{2} \operatorname{erfc} \left(\sqrt{\frac{E_s}{2N_0}} \right) + \frac{1}{4} \operatorname{erfc}^2 \left(\sqrt{\frac{E_s}{2N_0}} \right) \right] \quad (\text{B.8})$$

$$= 1 - \operatorname{erfc} \left(\sqrt{\frac{E_s}{2N_0}} \right) + \frac{1}{4} \operatorname{erfc}^2 \left(\sqrt{\frac{E_s}{2N_0}} \right) \quad (\text{B.9})$$

$$P_{e,QPSK} = 1 - f(c|s_2) \quad (\text{B.10})$$

$$= 1 - \left[1 - \operatorname{erfc} \left(\sqrt{\frac{E_s}{2N_0}} \right) + \frac{1}{4} \operatorname{erfc}^2 \left(\sqrt{\frac{E_s}{2N_0}} \right) \right] \quad (\text{B.11})$$

$$= \operatorname{erfc} \left(\sqrt{\frac{E_s}{2N_0}} \right) - \frac{1}{4} \operatorname{erfc}^2 \left(\sqrt{\frac{E_s}{2N_0}} \right) \quad (\text{B.12})$$

For higher values of E_s/N_0 , the approximated equation is:

$$P_{e,QPSK} \approx \operatorname{erfc} \left(\sqrt{\frac{E_s}{2N_0}} \right) \quad (\text{B.13})$$

APPENDIX C

SYMBOL ERROR RATE (SER) FOR 16-QAM MODULATION

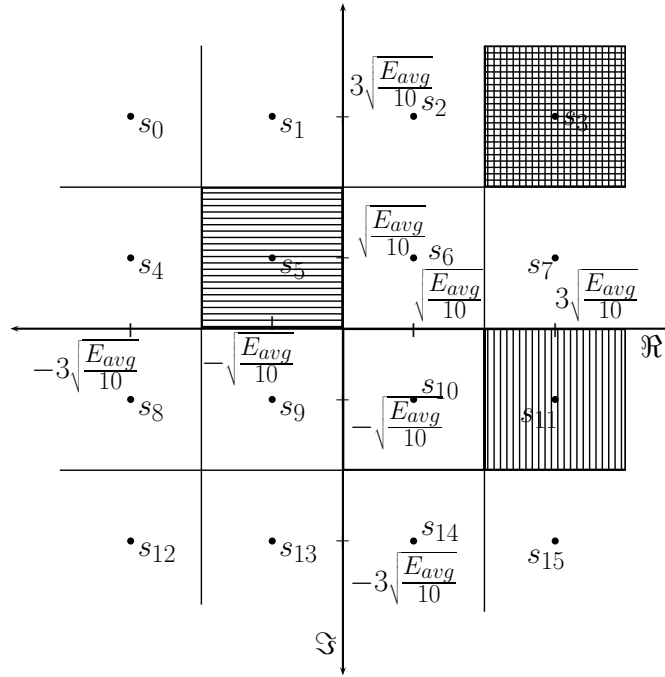

Figure C.1: 16-QAM constellation.

The average signal energy is given by:

$$E_{avg} = \sum_{m=1}^M p_m E_m \quad (C.1)$$

where pm is the message probability. E_m is symbol energy for message m , M is the modulation order, for 16-QAM, $M = 16$. If all symbols have the same probability (e.g equiprobable message) the equation (C.1) becomes:

$$E_{avg} = \frac{5}{2}d^2 \quad (C.2)$$

where d is the minimum distance between two consecutive constellations. In terms of average energy per bit E_{bavg} :

$$E_{bavg} = \frac{E_{avg}}{\log_2 M} \quad (C.3)$$

$$\frac{d}{2} = \sqrt{\frac{E_{avg}}{10}} \quad (C.4)$$

The alphabets of a 16-QAM modulation scheme are:

$$\alpha = \{\pm 1 + \pm 1j, \pm 1 + \pm 3j, \pm 3 + \pm 1j, \pm 3 + \pm 3j\}$$

The conditional probability distribution function (PDF) of y given s_5 was transmitted:

$$f(y/s_5) = \frac{1}{\sqrt{\pi N_0}} e^{-\frac{(y - \sqrt{\frac{E_{avg}}{10}})^2}{N_0}} \quad (C.5)$$

From figure C.1, symbol s_5 is detected correctly if y falls in the horizontally shaded area, i.e.,

$$f(c|s_5) = f\left(\Re\{y\} \leq 0, \Re\{y\} > -2\sqrt{\frac{E_{avg}}{10}} \mid s_5\right) \cdot f\left(\Im\{y\} > 0, \Im\{y\} \leq 2\sqrt{\frac{E_{avg}}{10}} \mid s_5\right)$$

Using the relation:

$$f(c|s_5) = \left[1 - \operatorname{erfc} \left(\sqrt{\frac{E_{avg}}{10N_0}} \right) \right] \left[1 - \operatorname{erfc} \left(\sqrt{\frac{E_{avg}}{10N_0}} \right) \right] \quad (\text{C.6})$$

The probability of error for s_5 is:

$$f(e|s_5) = 1 - \left[1 - \operatorname{erfc} \left(\sqrt{\frac{E_{avg}}{10N_0}} \right) \right]^2 \quad (\text{C.7})$$

$$\approx 2\operatorname{erfc} \left(\sqrt{\frac{E_{avg}}{10N_0}} \right) \quad (\text{C.8})$$

The conditional probability distribution function (PDF) of y given s_3 was transmitted is:

$$f(y/s_3) = \frac{1}{\sqrt{\pi N_0}} e^{-\frac{(y - \sqrt{\frac{E_{avg}}{10}})^2}{N_0}} \quad (\text{C.9})$$

From Figure 6, symbol s_3 is detected correctly if y falls in the crossed shaded area, i.e.,

$$f(c|s_3) = f\left(\Re\{y\} > 2\sqrt{\frac{E_{avg}}{10}} | s_3\right) f\left(\Im\{y\} > 2\sqrt{\frac{E_{avg}}{10}} | s_3\right)$$

Using the relation:

$$f(c|s_3) = \left[1 - \frac{1}{2}\operatorname{erfc} \left(\sqrt{\frac{E_{avg}}{10N_0}} \right) \right] \left[1 - \frac{1}{2}\operatorname{erfc} \left(\sqrt{\frac{E_{avg}}{10N_0}} \right) \right] \quad (\text{C.10})$$

The probability of error for s_3 is:

$$f(e|s_3) = 1 - \left[1 - \frac{1}{2} \operatorname{erfc} \left(\sqrt{\frac{E_{avg}}{10N_0}} \right) \right]^2 \quad (\text{C.11})$$

$$\approx \operatorname{erfc} \left(\sqrt{\frac{E_{avg}}{10N_0}} \right) \quad (\text{C.12})$$

The conditional probability distribution function (PDF) of y given s_{11} was transmitted:

$$f(y|s_{11}) = \frac{1}{\sqrt{\pi N_0}} e^{-\frac{(y - \sqrt{\frac{E_{avg}}{10}})^2}{N_0}} \quad (\text{C.13})$$

From figure C.1, symbol s_{11} is detected correctly if y falls in the vertically shaded area, i.e.,

$$f(c|s_{11}) = f\left(\Re\{y\} > 2\sqrt{\frac{E_{avg}}{10}} | s_{11}\right) f\left(\Im\{y\} \leq 0, \Im\{y\} > -2\sqrt{\frac{E_{avg}}{10}} | s_{11}\right)$$

Using the above two cases as reference

$$f(c|s_{11}) = \left[1 - \frac{1}{2} \operatorname{erfc} \left(\sqrt{\frac{E_{avg}}{10N_0}} \right) \right] \left[1 - \operatorname{erfc} \left(\sqrt{\frac{E_{avg}}{10N_0}} \right) \right] \quad (\text{C.14})$$

The probability of error of s_{11} :

$$f(e|s_{11}) = 1 - \left[1 - \frac{1}{2} \operatorname{erfc} \left(\sqrt{\frac{E_{avg}}{10N_0}} \right) \right] \left[1 - \operatorname{erfc} \left(\sqrt{\frac{E_{avg}}{10N_0}} \right) \right] \quad (\text{C.15})$$

$$\approx \frac{3}{2} \operatorname{erfc} \left(\sqrt{\frac{E_{avg}}{10N_0}} \right) \quad (\text{C.16})$$

The total symbol probability of 16-QAM:

$$P_{e,16QAM} \approx \frac{3}{2} \operatorname{erfc} \left(\sqrt{\frac{E_{avg}}{10N_0}} \right) \quad (\text{C.17})$$